

50 ICAR



ICAR

The Italian Farrier Tools
MANIAGO



CATALOGO MASCALCIA



“Qui a Maniago l'arte di forgiare coltelli ha radici antichissime.

La nostra famiglia, fin dalla fondazione di ICAR da parte di Giusto Grisostolo, Giovanni e Romano Antonini, porta avanti questa tradizione. Ancora oggi il lavoro artigianale ci permette di fare la differenza nel mondo.”

Gloriana Grisostolo - CEO

www.icarforgiati.it

Nel 2012 la nostra azienda decise di intraprendere il progetto **ICAR FARRIER TOOLS**, iniziando a realizzare strumenti da **mascalcia** con l'intento di creare dei prodotti **di alta qualità** che riuscissero a soddisfare le esigenze dei maniscalchi.

I feedback di questi ultimi, uniti alle intuizioni dei nostri progettisti, ci hanno consentito di raggiungere un livello qualitativo elevatissimo che ci viene **ricosciuto in tutto il mondo**.

ICAR

*Radici nel passato,
sguardo al futuro,
piedi nel presente.*

50 *anni insieme
per darvi il meglio*



punte calibrate per il foro del ferro	
ganasce multiple	
forgiato a caldo	
manici ergonomici	
nuovo design del bullone	
affilato a mano	
acciaio ad alto tenore di carbonio	
manico forgiato a caldo in alluminio	
zigrinatura	
uncino nettapiedi pulizia scanalature	
taglio molto penetrante	
fornito di magneti	
lama intercambiabile	
per modelli bovini	
impugnatura ergonomica	
manico in ciliegio	
manico in mogano	
manico in kolibè	
manico in hickory americano	
bilanciato ed equilibrato	
trattamento termico differenziato	
acciaio inox	
impugnatura assorbi vibrazioni in EVA (etilene vinil acetato)	
sterilizzabile in autoclave	

il nuovo catalogo **ICAR** per la MASCALCIA

All'interno di questo catalogo troverete gli attrezzi ICAR per la mascalcia, realizzati con materiali europei di primissima qualità e forgiati a mano, frutto dell'esperienza di tre generazioni di artigiani.

INDICE

TENAGLIE

	DA PAREGGIO	pagg.	4-7
	TAGLIACHIODI	pagg.	8-10
	LEVAFERRI	pag.	11
	TIRACHIODI	pagg.	12-14
	LEVACHIODI	pag.	14

PINZE

	A SONDARE	pag.	16
	POSIZIONA FERRI	pag.	17
	ALLARGAFERRI	pag.	18
	PINZE DA FORGIA	pag.	18

COLTELLI

	INGLESI E KNIFERGO	pagg.	20-21
	PVF	pagg.	22-23
	VET E BOVINI	pagg.	24-25
	COLTELLACCI	pag.	26

INCASSINI E SCASSACHIODI

	INCASSINI	pagg.	28-29
	SCASSACHIODI	pag.	29

MARTELLI

	DA FORGIA	pagg.	32-34
	PER FERRARE	pag.	34

ACCESSORI

	FORBICI	pag.	36
	CURASNETTA	pag.	37
	TREKKING KNIFE	pag.	37
	EDIZIONI SPECIALI	pag.	38
	RICAMBI	pagg.	39-40

Per permettere la **più elevata resistenza** allo stress meccanico, realizziamo le **tenaglie ICAR** con **forgiatura a caldo** utilizzando unicamente il **migliore acciaio europeo**

Il design delle nostre tenaglie è studiato nei minimi particolari per garantire **"comfort alla mano"**, i manici ergonomici consentono un **utilizzo intensivo con il minimo sforzo**.

Qui alla ICAR otteniamo un **filo di taglio molto penetrante, netto e di lunga durata** grazie ai **trattamenti termici dei materiali**. Abbiamo ridisegnato un nuovo bullone per minimizzare il gioco tra le ganasce e ottenere un **taglio il più preciso possibile**.

Uniamo **l'alta tecnologia CNC** alla minuziosa **rifinitura artigianale** per garantirvi le tenaglie della **migliore qualità**.



forgiato a caldo



manici ergonomici



nuovo design del bullone



taglio molto penetrante



fornito di magneti



zigrinatura



uncino nettapiedi e pulizia scandature



trattamento termico differenziato



TENAGLIE

DA PAREGGIO

TAGLIACHIODI

LEVA FERRI

TIRACHIODI

LEVACHIODI



TENAGLIA *Race Track*

versioni disponibili:

Art. 4001/12" RT

Lunghezza 305 mm

Peso ~ 660 gr

Art. 4001/14" RT

Lunghezza 350 mm

Peso ~ 720 gr

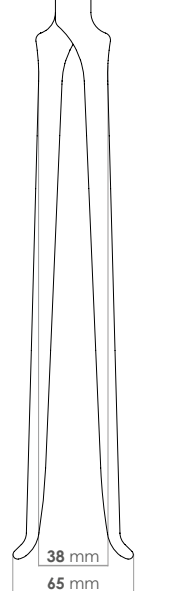
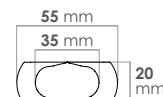

TENAGLIA *Testa Media*

versioni disponibili:

Art. 4004/14"

Lunghezza 350 mm

Peso ~ 730 gr

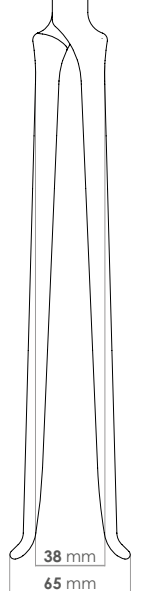
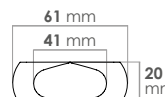



www.icarforgiati.it



TENAGLIA da Pareggio

versioni disponibili:

Art. 4001/14"
Lunghezza 350 mm
Peso ~ 790 gr

Art. 4001/15"
Lunghezza 375 mm
Peso ~ 680 gr

Art. 4001/16"
Lunghezza 405 mm
Peso ~ 760 gr

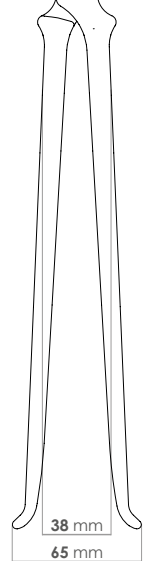
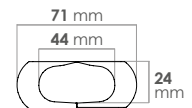
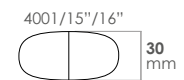



apertura massima
22 mm



TENAGLIA
Puledri
apertura a molla

versioni disponibili:

Art. 4009/10"
Lunghezza 250 mm
Peso ~ 610 gr

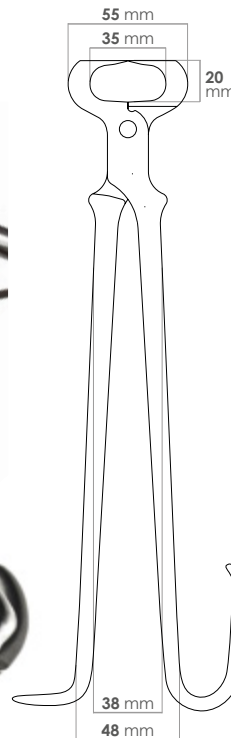

TENAGLIA
Mezzatonda
testa stretta

versioni disponibili:

Art. 4010/12" 3/8
Lunghezza 305 mm
Peso ~ 570 gr

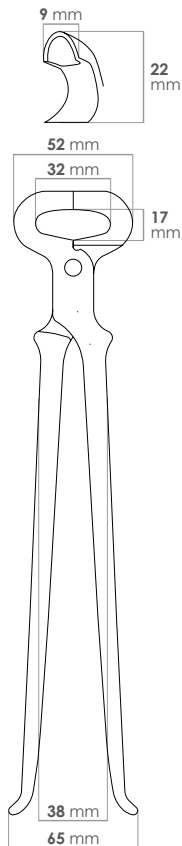



www.icarforgiati.it



TENAGLIA
Mezzatonda
punta acuta

versioni disponibili:

Art. 4010/12" 3/8 PJ
Lunghezza 305 mm
Peso ~ 570 gr

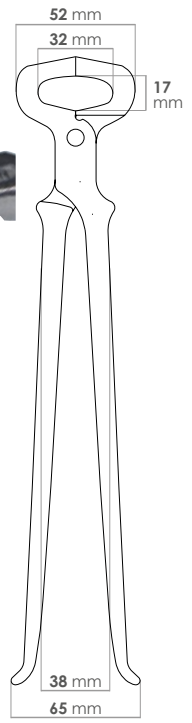

TENAGLIA
Mezzatonda

versioni disponibili:

Art. 4010/12"
Lunghezza 305 mm
Peso ~ 620 gr

Art. 4010/14"
Lunghezza 350 mm
Peso ~ 670 gr

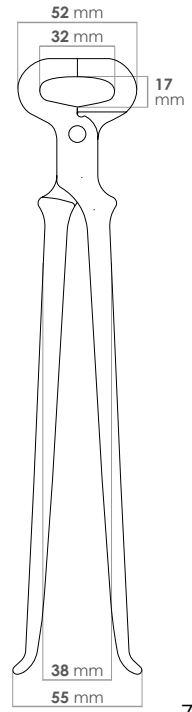



TENAGLIA *Tagliachiodi*

versioni disponibili:

Art. 4006/10"

Lunghezza 255 mm

Peso ~ 550 gr

Art. 4006/12"

Lunghezza 305 mm

Peso ~ 630 gr

Art. 4006/14"

Lunghezza 350 mm

Peso ~ 710 gr

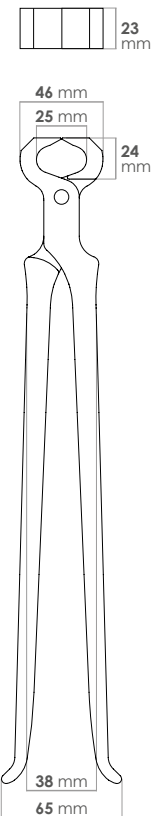



www.icarforgiati.it



TENAGLIA
Tagliachiodi con magneti

versioni disponibili:

Art. 4006/10" MAG
Lunghezza 255 mm
Peso ~ 550 gr

Art. 4006/12" MAG
Lunghezza 305 mm
Peso ~ 630 gr

Art. 4006/14" MAG
Lunghezza 350 mm
Peso ~ 710 gr

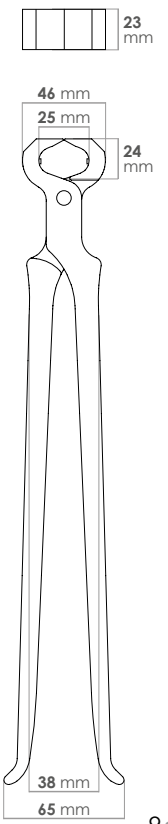

TENAGLIA
Tagliachiodi
con magneti
1 testa incudine

versioni disponibili:

Art. 4006/12" AM
Lunghezza 305 mm
Peso ~ 610 gr

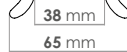
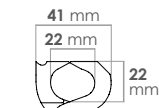

TENAGLIA
Tagliachiodi
con magneti
2 teste incudine

versioni disponibili:

Art. 4006/12" 2AM
Lunghezza 305 mm
Peso ~ 610 gr

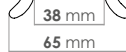
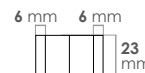



www.icarforgiati.it



TENAGLIA
Levaferri

3 usi
sferra allarga
taglia

versioni disponibili:

Art. 4002/12"
Lunghezza 305 mm
Peso ~ 680 gr

Art. 4002/14"
Lunghezza 350 mm
Peso ~ 760 gr



TENAGLIA
Levaferri

4 usi
sferra allarga
taglia netta

versioni disponibili:

Art. 4003/12"
Lunghezza 305 mm
Peso ~ 700 gr

Art. 4003/14"
Lunghezza 350 mm
Peso ~ 780 gr

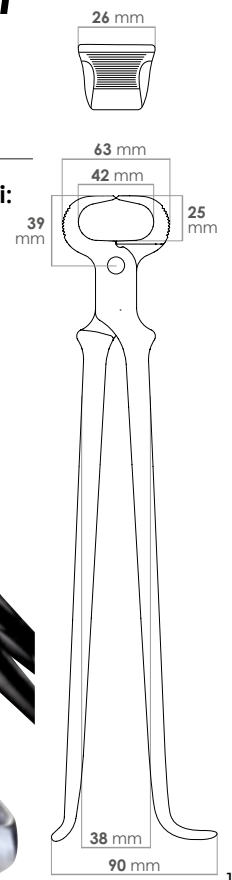



TENAGLIA
Dragon 2.0
draft

versioni disponibili:

Art. 4007/14" DH
Lunghezza 345 mm
Peso ~ 710 gr

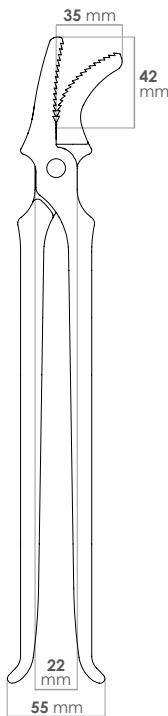
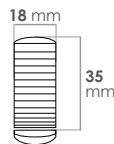

TENAGLIA
Dragon 2.0
quarter

versioni disponibili:

Art. 4007/14" QH
Lunghezza 345 mm
Peso ~ 710 gr

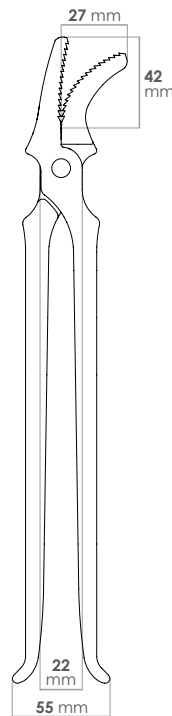
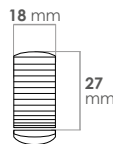



www.icarforgiati.it



TENAGLIA
Dragon 2.0
race

versioni disponibili:

Art. 4007/14" RH
Lunghezza 345 mm
Peso ~ 690 gr

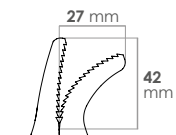
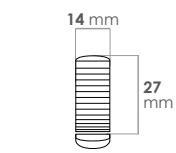

TENAGLIA
Dragon 2.0
chiodi bassi

versioni disponibili:

Art. 4107/12" LN
Lunghezza 305 mm
Peso ~ 630 gr

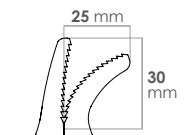
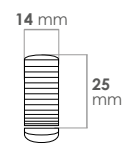



TENAGLIA
Dragon 2.0
linea S

versioni disponibili:

Art. 4007/14" QH "S"
Lunghezza 340 mm
Peso ~ 710 gr

Art. 4007/14" RH "S"
Lunghezza 340 mm
Peso ~ 690 gr

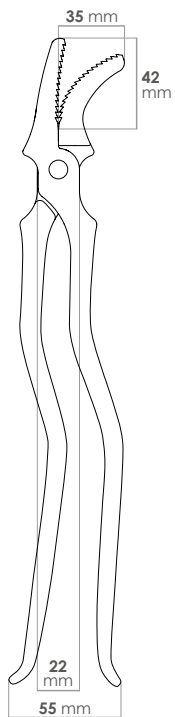
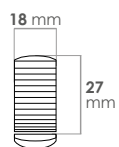

TENAGLIA
Levachiodi

versioni disponibili:

Art. 4011/12"
Lunghezza 305 mm
Peso ~ 520 gr

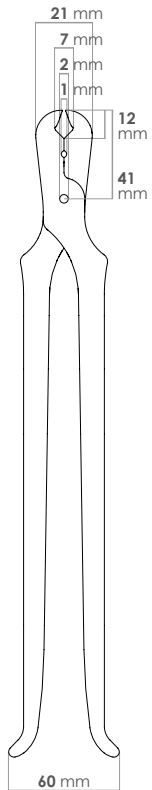

Per permettere la **più elevata resistenza** allo stress meccanico, realizziamo le **pinze ICAR** con **forgiatura a caldo** utilizzando unicamente il **migliore acciaio europeo**

Il design delle nostre pinze è **studiato nei minimi particolari** per garantire "**comfort alla mano**", i manici ergonomici consentono un utilizzo intensivo con il **minimo sforzo**, le teste sono disegnate per una **presa ottimale**.

Abbiamo ridisegnato il **nuovo bullone per minimizzare il gioco tra le ganasce**.

Qui alla ICAR uniamo **l'alta tecnologia CNC** alla minuziosa **rifinitura artigianale** per garantirvi le pinze della **migliore qualità**.



PINZE



forgiato a caldo



manici ergonomici



nuovo design del bullone



trattamento termico differenziato



zigrinatura



punte calibrate per il foro del ferro



ganasce multiple

A SONDARE

POSIZIONA FERRI

ALLARGA FERRI

PINZE DA FORGIA



PINZA
a Sondare 2.0

versioni disponibili:

Art. 4008/16"
Lunghezza 405 mm
Peso ~ 780 gr

Art. 4008/19"
Lunghezza 485 mm
Peso ~ 970 gr

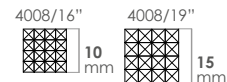

4008/16": 120 mm
4008/19": 135 mm

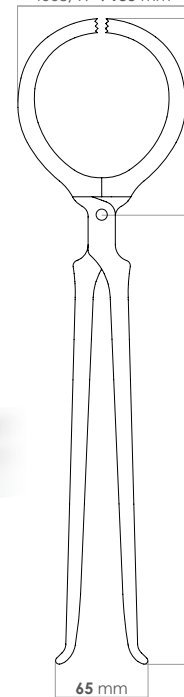

4008/16":
140 mm
4008/19":
165 mm

4008/16":
265 mm
4008/19":
320 mm

65 mm



PINZA
Posiziona Ferri
punte rette

versioni disponibili:

Art. 4005/13" ST
Lunghezza 330 mm
Peso ~ 590 gr

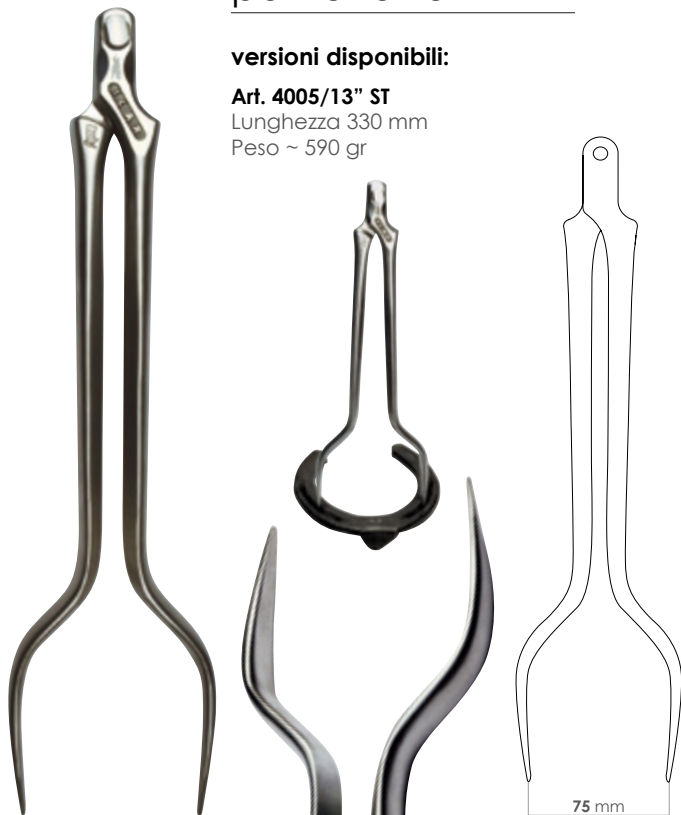

PINZA
Posiziona Ferri
punte curve

versioni disponibili:

Art. 4005/13" CT
Lunghezza 330 mm
Peso ~ 590 gr





**PINZE
ALLARGAFERRI**



**PINZE
DA FORGIA**

PINZA

Allargaferrì

versioni disponibili:

Art. 4012/15"

Lunghezza 375 mm

Peso ~ 880 gr



PINZE DA FORGIA

Firex

versioni disponibili:

Art. 4300/16" 1/8"

Art. 4300/16" 1/4"

Art. 4300/16" 5/16"

Art. 4300/16" 3/8"

Art. 4300/16" 1/2"

Lunghezza 410 mm

Peso ~ 720 gr

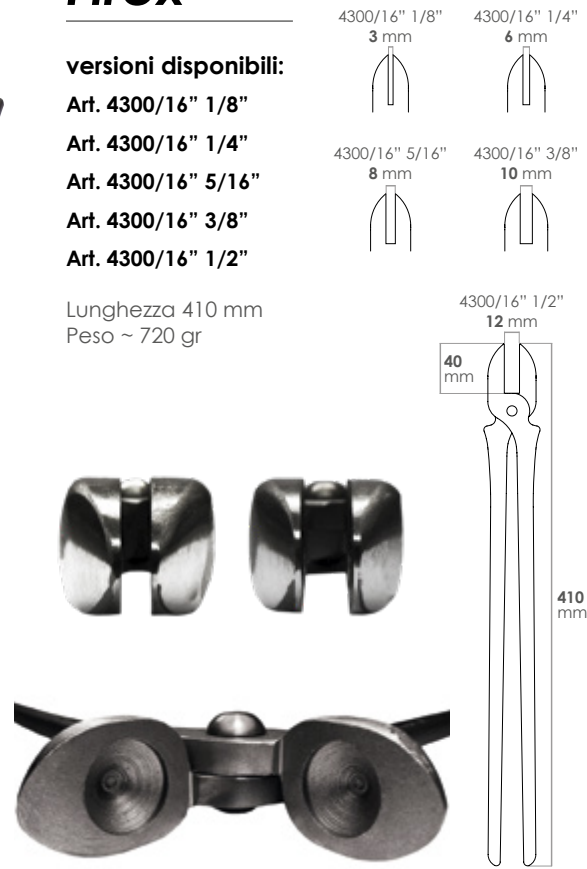

Dall'ottima qualità del **migliore acciaio europeo** otteniamo i **coltelli ICAR** con taglio **molto penetrante** e di **lunga durata**, **affilati artigianalmente a mano** e controllati uno ad uno

Il design del manico permette **una presa perfetta** per ogni tipo di mano, leggerezza ed ergonomia consentono un utilizzo confortevole **per realizzare tagli netti e più precisi**. Il disegno della lama, le sue lavorazioni e l'affilatura artigianale donano **durevole efficienza e qualità superiore ai nostri coltelli**.

La linea "VET" è studiata per essere **sterilizzabile in autoclave**.



COLTELLI



forgiato a caldo



affilato a mano



lama intercambiabile



per modelli bovini



taglio molto penetrante



acciaio ad alto
tenore di carbonio



sterilizzabile in autoclave



acciaio inox



impugnatura ergonomica



impugnatura assorbi vibrazioni
in EVA (etilene vinil acetato)



manico forgiato a
caldo in alluminio



manico in mogano



manico in ciliegio



manico in kotibè



INGLESÌ E KNIFERGO

PVF

VET E BOVINI

COLTELLACCI



COLTELLO Inglese

versioni disponibili:

lama classica

Art. 4020/21 DX

Art. 4020/21 SX

Lama fissa

Art. 4019/21 DX

Art. 4119/21 SX

Lama
intercambiabile

Lunghezza 210 mm

Peso ~ 120 gr

lama drop

Art. 4025/21 DX

Art. 4125/21 SX

Lama fissa

Art. 4026/21 DX

Art. 4126/21 SX

Lama
intercambiabile

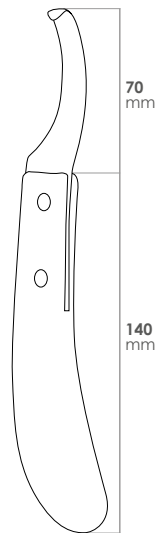

COLTELLO Loop

versioni disponibili:

37 mm

Art. 4029/22

Lunghezza 210 mm

Peso ~ 120 gr

50 mm

Art. 4028/22

Lunghezza 210 mm

Peso ~ 120 gr

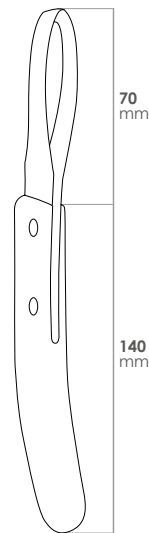



COLTELLO
**Pleasant
Valley Forge**
lama larga

versioni disponibili:

Art. 4052/20 DESTRO
Lunghezza 210 mm
Peso ~ 90 gr

Art. 4152/20 SINISTRO
Lunghezza 210 mm
Peso ~ 90 gr

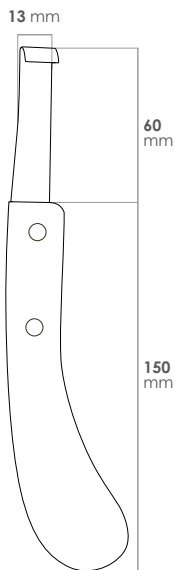

COLTELLO
**Pleasant
Valley Forge**
lama stretta

versioni disponibili:

Art. 4051/20 DESTRO
Lunghezza 210 mm
Peso ~ 90 gr

Art. 4151/20 SINISTRO
Lunghezza 210 mm
Peso ~ 90 gr

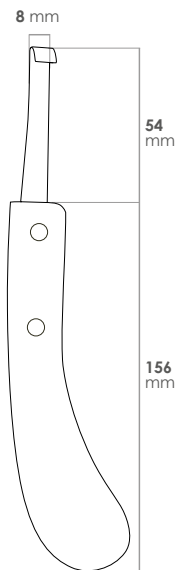



COLTELLO
**Pleasant
Valley Forge**
lama a doppio filo

versioni disponibili:

Art. 4050/20
Lunghezza 210 mm
Peso ~ 90 gr

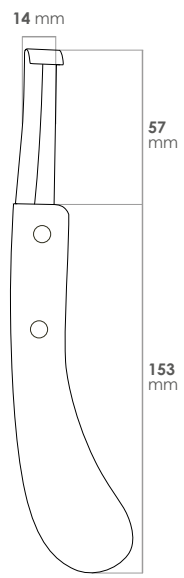

COLTELLO
**Pleasant
Valley Forge**
loop lama forgiata

versioni disponibili:

Art. 4053/21
Lunghezza 210 mm
Peso ~ 120 gr

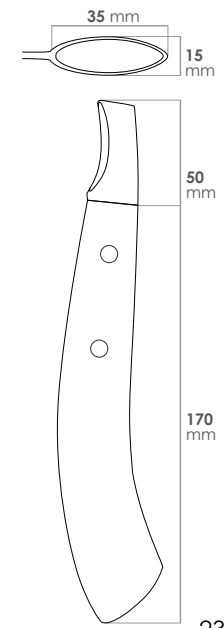



COLTELLO
Vet 2.0
lama classica

versioni disponibili:

Art. 4066/21 DX

Art. 4166/21 SX

Lama fissa

Lunghezza 210 mm

Peso ~ 210 gr

COLTELLO
Vet 2.0
lama drop

versioni disponibili:

Art. 4067/21 DX

Art. 4167/21 SX

Lama intercambiabile

Lunghezza 210 mm

Peso ~ 210 gr

COLTELLO
Vet 2.0
loop lama forgiata

versioni disponibili:

Art. 4069/21

Lunghezza 190 mm

Peso ~ 210 gr





COLTELLO
Vet 2.0
lama ascessi

versioni disponibili:

11 mm
Art. 4068/19-11
Lunghezza 210 mm
Peso ~ 210 gr



19 mm
Art. 4068/19-19
Lunghezza 210 mm
Peso ~ 210 gr



COLTELLO
Inglese
per piano d'appoggio bovino

versioni disponibili:

Art. 4055/21 DX
Art. 4155/21 SX
Lama fissa

Lunghezza 210 mm
Peso ~ 120 gr

Art. 4056/21 DX
Art. 4156/21 SX
Lama intercambiabile

Lunghezza 210 mm
Peso ~ 120 gr

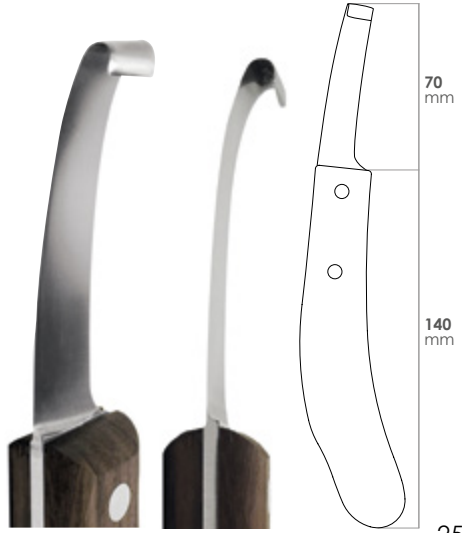



COLTELLACCIO
Punta Retta

versioni disponibili:

Art. 4086/36 cm

Lunghezza 360 mm

Peso ~ 200 gr

Art. 4086/28 cm

Lunghezza 280 mm

Peso ~ 140 gr



COLTELLACCIO
Punta Tonda

versioni disponibili:

Art. 4087/36 cm

Lunghezza 360 mm

Peso ~ 200 gr

Art. 4087/28 cm

Lunghezza 280 mm

Peso ~ 140 gr

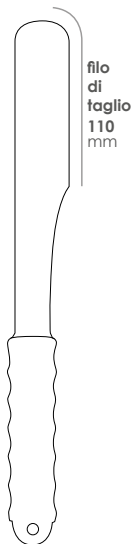

Grazie al design studiato per una **impugnatura confortevole**, gli **incassini** e lo **scassachiodi ICAR** sono **ergonomici** e si adattano ad ogni tipo di mano

Abbiamo voluto rivisitare **il taglio dei nostri incassini** per renderlo ancor più **netto, preciso e prestante**, inoltre la diversa larghezza della scanalatura permette di poter scegliere il modello più adatto a seconda della dimensione del chiodo.

I **manici ergonomici** *Eva* e in *legno di mogano* sono eccellenti materiali **antiscivolo, antisudore e antivibrazione**.

Per permettere la più elevata resistenza alle sollecitazioni meccaniche, lo scassachiodi ICAR è realizzato con **forgiatura a caldo** utilizzando unicamente **il migliore acciaio europeo**.

Uniamo **l'alta tecnologia CNC** alla minuziosa **rifinitura artigianale** per garantirvi incassini e scassachiodi della **migliore qualità**.



INCASSINI E SCASSACHIODI



forgiato a caldo



acciaio ad alto
tenore di carbonio



acciaio inox



taglio molto penetrante



impugnatura ergonomica



manico in mogano



impugnatura assorbi vibrazioni
in EVA (etilene vinil acetato)

INCASSINI

SCASSACHIODI





Incassino Johnny

versioni disponibili:

4 mm

5 mm

Art. 4090/16 DX

Art. 4090/16 DX

Art. 4190/16 SX

Art. 4190/16 SX

Lunghezza 160 mm

Lunghezza 160 mm

Peso ~ 180 gr

Peso ~ 180 gr



160
mm

Incassino Black Panther

versioni disponibili:

4 mm

5 mm

Art. 4093/20 DX

Art. 4093/20 DX

Art. 4193/20 SX

Art. 4193/20 SX

Lunghezza 200 mm

Lunghezza 200 mm

Peso ~ 200 gr

Peso ~ 200 gr

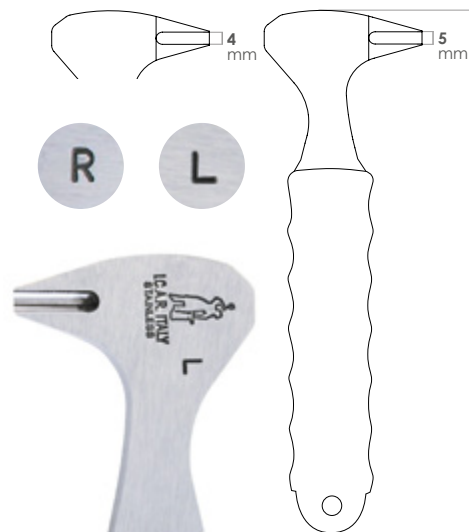

200
mm



Incassino

Johnny 2.0

versioni disponibili:

4 mm

Art. 4092/20 DX

Art. 4192/20 SX

Lunghezza 200 mm

Peso ~ 160 gr

5 mm

Art. 4092/20 DX

Art. 4192/20 SX

Lunghezza 200 mm

Peso ~ 160 gr

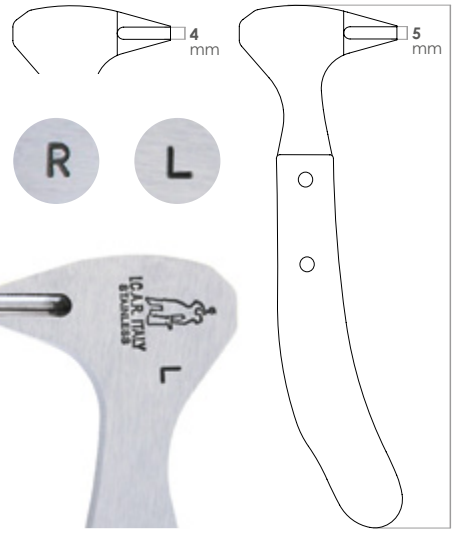

Scassachiodi

versioni disponibili:

Art. 4091/16 DX

Lunghezza 170 mm

Peso ~ 240 gr

Art. 4191/16 SX

Lunghezza 170 mm

Peso ~ 240 gr





TAGLIO GIUSTO, TAGLIO GUSTO



ICAR, Garanzia di Qualità Superiore!

Il punto di forza del nostro lavoro nasce dalle esperienze accumulate negli anni e dalla capacità di comprendere le specifiche esigenze dei nostri Clienti



Ralizziamo i **martelli ICAR super bilanciati** con processo di **forgiatura a caldo**, che garantisce **un'elevata resistenza** alle sollecitazioni meccaniche

Il processo di lavorazione e il **super bilanciamento** garantiscono un ottimo e confortevole controllo nell'utilizzo dei nostri martelli.

Per una presa ideale, salda e sicura il manico, dal design ergonomico, è in *hickory americano*, legno selezionato per la sua **efficacia nell'assorbire le vibrazioni e per essere antisudore**.

Il **comodo magnete** di cui sono provvisti i nostri martelli per ferrare consente di raccogliere i chiodi a distanza.

Uniamo l'**alta tecnologia CNC** alla minuziosa **rifinitura artigianale** per garantirvi i martelli della **migliore qualità**.



MARTELLI



forgiato a caldo



manici ergonomici



bilanciato ed equilibrato



manico in hickory americano



fornito di magneti

DA FORGIA

PER FERRARE



MARTELLINO *da Forgia*

versioni disponibili:

Art. 4200/1 1/2 Lb 700

Lunghezza 440 mm

Peso ~ 700 gr

Art. 4200/1 3/4 Lb 800

Lunghezza 440 mm

Peso ~ 800 gr

Art. 4200/2 Lb 900

Lunghezza 440 mm

Peso ~ 900 gr

Art. 4200/2 1/4 Lb 1000

Lunghezza 440 mm

Peso ~ 1000 gr

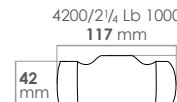
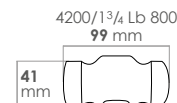
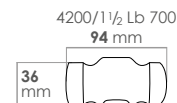

440
mm



MARTELO TIRA BARBETTE
Penna Traversa

versioni disponibili:

Art. 4202/13/4 Lb 800
Lunghezza 440 mm
Peso ~ 800 gr

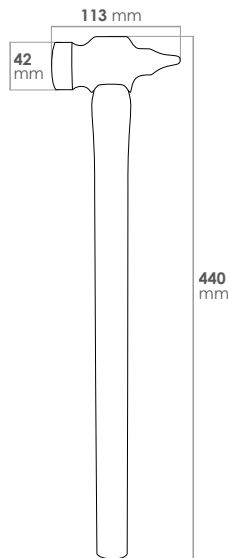

MARTELO TIRA BARBETTE
Penna Dritta

versioni disponibili:

Art. 4203/13/4 Lb 800
Lunghezza 440 mm
Peso ~ 800 gr

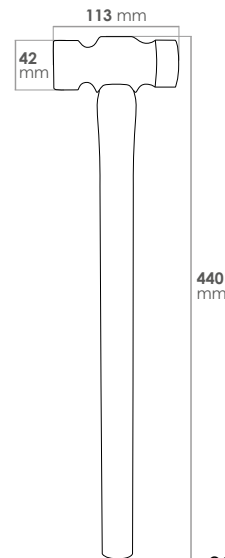



MARTELLI
DA FORGIA



MARTELLI
PER FERRARE



MARTELO DA FORGIA
a Palla

versioni disponibili:

Art. 4201/2 Lb 900
Lunghezza 440 mm
Peso ~ 900 gr

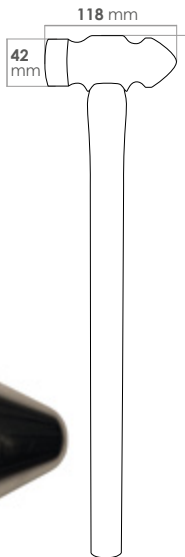

440 mm



MARTELO
Per Ferrare

versioni disponibili:

Art. 4250/10 oz.
Lunghezza 365 mm
Peso ~ 285 gr

Art. 4250/12 oz.
Lunghezza 365 mm
Peso ~ 340 gr

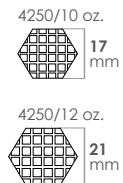

365 mm



Gli **accessori ICAR** sono realizzati utilizzando unicamente il **migliore acciaio europeo**. I **ricambi ICAR** sono prodotti **ecofriendly** per il rispetto dell'ambiente

Per ottenere **un filo di taglio eccezionale, affilato e durevole nel tempo forgiamo a caldo** le forbici tagliacuoio ICAR, che sono adatte sia al taglio della plastica che del cuoio.

La forma della sua lama permette di realizzare **il taglio tondeggiante** seguendo la sagoma della suola.

La **presa confortevole per un utilizzo intensivo** è garantita dai manici rivestiti in pvc rosso.



ACCESSORI



forgiato a caldo



affilato a mano



taglio molto penetrante



acciaio ad alto
tenore di carbonio



acciaio inox



sterilizzabile in autoclave



impugnatura ergonomica



manico in mogano

FORBICI

CURASNETTA

TREKKING KNIFE

EDIZIONI SPECIALI

RICAMBI



FORBICI
TAGLIACRINE

FORBICI
Tagliacrine

versioni disponibili:

Art. 2070/6" IS

Lunghezza 155 mm

Peso ~ 54 gr



FORBICI
TAGLIACUOIO

FORBICI
Tagliacuoio

versioni disponibili:

Art. 2298/9" BPVC

Lunghezza 230 mm

Peso ~ 350 gr





Curasnetta

versioni disponibili:

Art. 4040/24

Lunghezza 230 mm

Peso ~ 140 gr

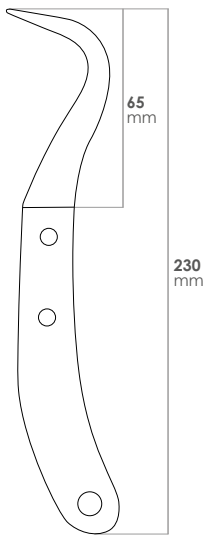

Derby Trekking Knife

versioni disponibili:

Art. MC87/2

Lunghezza 197 mm

Peso ~ 160 gr

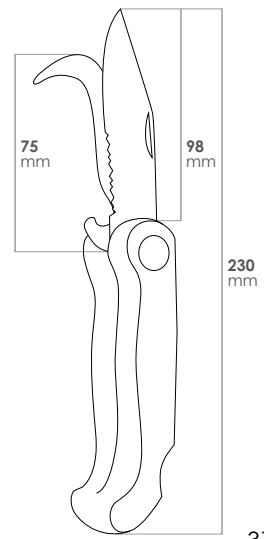



Manici Decorati

Processo decorativo a sublimazione

Con questo speciale trattamento di sublimazione vi possiamo fornire i nostri articoli decorati con decine di motivi, oltre a quelli che potete vedere in questa selezione.



lavorazione disponibile sui seguenti articoli:

Tenaglie da Pareggio • Tenaglie Tagliachiodi
Tenaglie Levaferrì • Tenaglie Tirachiodi
Tenaglie Levachiodi • Pinze a Sondare



Oro

Placcatura oro 24 K

Eseguiamo la placcatura in oro 24 K per le vostre occasioni speciali



lavorazione disponibile sui seguenti articoli:

Tenaglie da Pareggio • Tenaglie Tagliachiodi • Tenaglie Levaferrì
Tenaglie Tirachiodi • Tenaglie Levachiodi • Pinze a Sondare
Martelli da Forgia • Martelli per Ferrare



LAMA CLASSICA

Ad alto Tenore di Carbonio

**Art. 4022B21 DX
Art. 4122B21 SX**

Lunghezza 130 mm
Filo di taglio 60 mm
Peso ~ 40 gr



LAMA CLASSICA

Forgiata in Acciaio Inox

**Art. 4060B21 DX
Art. 4160B21 SX**

Lunghezza 130 mm
Filo di taglio 60 mm
Peso ~ 40 gr



LAMA DROP

Ad alto Tenore di Carbonio

**Art. 4024B21 DX
Art. 4124B21 SX**

Lunghezza 130 mm
Filo di taglio 60 mm
Peso ~ 40 gr



LAMA DROP

Forgiata in Acciaio Inox

**Art. 4061B21 DX
Art. 4161B21 SX**

Lunghezza 130 mm
Filo di taglio 60 mm
Peso ~ 40 gr



**LAMA LOOP
ASCESSI**

Forgiata in Acciaio Inox

Art. 4068B19 19mm

Lunghezza 126 mm
Filo di taglio 19 mm
Peso ~ 40 gr



**LAMA LOOP
ASCESSI**

Forgiata in Acciaio Inox

Art. 4068B19 11mm

Lunghezza 126 mm
Filo di taglio 11 mm
Peso ~ 40 gr



**LAMA
COLTELLI BOVINI**

Forgiata in Acciaio Inox

**Art. 4056B21 DX
Art. 4156B21 SX**

Lunghezza 130 mm
Filo di taglio 67 mm
Peso ~ 40 gr



LAMA LOOP

Forgiata in Acciaio Inox

Art. 4069B21

Lunghezza 100 mm
Filo di taglio 35 mm
Peso ~ 50 gr



MOLLA DI RICAMBIO

Tenaglia
per Puledri

Art. 1361040091

Lunghezza 165 mm
Spessore 10 mm
Peso ~ 10 gr



NASTRO AUTOVULCANIZZANTE in Silicone

Art. 1706200250

Lunghezza 3 m
Larghezza 25 mm
Peso ~ 50 gr



MANICI MARTELLI in Legno di HICKORY Americano

Ricambio manico
martello da forgia

Lunghezza 440 mm
Larghezza 35 mm
Profondità 23 mm
Peso ~ 220 gr

Ricambio manico
martello per ferrare

Lunghezza 370 mm
Larghezza 26 mm
Profondità 19 mm
Peso ~ 280 gr

Termini di Garanzia

ICAR garantisce che i suoi prodotti sono privi di difetti nei materiali e nelle manufatti. Nel caso in cui un qualsiasi strumento dovesse presentare una qualsiasi imperfezione la cosa dovrebbe essere fatta rilevare al rivenditore oppure direttamente ad ICAR che provvederà a dare istruzioni per risolvere il problema dopo aver lo esaminato. Nel caso l'ispezione e i test rivelino che il prodotto non è conforme allo standard qualitativo, lo stesso verrà riparato o sostituito a discrezione della ICAR. Attrezzi alterati, abusati, utilizzati in maniera non corretta o semplicemente usurati non saranno coperti da questa garanzia.

Attenzione

Suggeriamo l'utilizzo di occhiali protettivi, così come l'adozione di ogni altra precauzione necessaria in ambiente di lavoro. Raccomandiamo di evitare urti tra particolari temprati.

Consigli per la Manutenzione

Dopo ogni utilizzo gli attrezzi dovrebbero essere puliti, prestando molta cura alla rimozione della sporcizia e di eventuali corpi estranei, lubrificati con olio e grasso.

Note Aggiuntive

Tutte le misure degli strumenti all'interno del catalogo sono approssimative, pertanto possono esserci delle lievi variazioni dovute alla lavorazione e finitura essenzialmente manuale.

100% Made in Italy

I nostri strumenti vengono prodotti interamente nel nostro stabilimento di Maniago (PN) utilizzando solo acciai europei.

www.icarforgiati.it



50
50 anni insieme
per darvi il meglio



www.icarforgiati.it

ICAR S.r.l.

Via Maniago 101
33085 **Maniago** (PN) ITALY

Phone: +39(0)427.71106

Fax: +39(0)427.700171

info@icarforgiati.it



@ICAR Srl



@ICAR_forge

